

DISTRIBUTEUR MONOBLOC  
MONOBLOCK VALVE  
DISTRIBUIDOR MONOBLOQUE

Qn  
25 l/min

Qmax  
35 l/min

BM 35

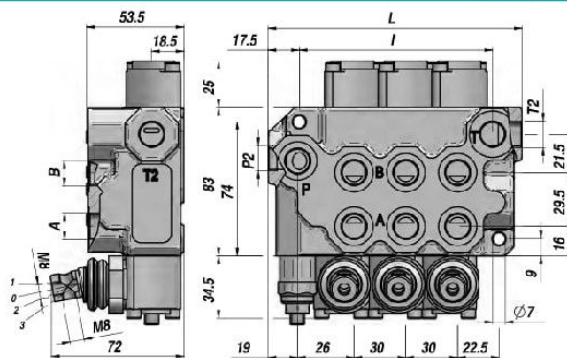
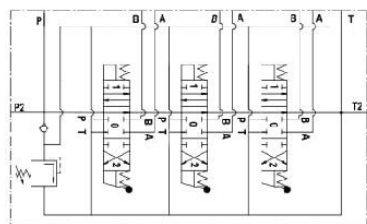

Code Code Código	Type Type Tipo	N° Leviers Sections No. Nr. Palancas	Orifices - Threads - Orificios					PN bar	P MAX U bar	P MAX S bar	L	I	kg
			A-B BSP	P BSP	T BSP	P2 BSP	T2 BSP						
DBM8111001	BM 35/1/GU/MO A1	1								81.5	50	1.80	
DBM8211001	BM 35/2/GU/MO A1 x 2	2							111.5	80	2.70		
DBM8311001	BM 35/3/GU/MO A1 x 3	3							141.5	110	3.80		
DBM8411001	BM 35/4/GU/MO A1 x 4	4	3/8"	3/8"	3/8"	3/8"	3/8"	250	320	80	171.5	140	4.60
DBM8511001	BM 35/5/GU/MO A1 x 5	5							201.5	170	5.40		
DBM8611001	BM 35/6/GU/MO A1 x 6	6							231.5	200	6.20		

PN = Pression nominale - Nominal pressure - Presión nominal  
 P MAX U = Pression maxi sur les orifices - Max. pressure on ports - Presión Max. sobre los orificios  
 P MAX S = Pression maxi sur le retour - Max. pressure in tank-line - Presión Max. al retorno

Limiteur de pression - Relief Valve - Limitador de presión: X = 30:90 bar (70) - U = 80:230 bar (140) (Standard) - K = 150:300 bar (200)

LES CODES CORRESPONDENT A - THESE CODES AND PRICES REFER TO - LOS CODIGOS SE REFIEREN A LOS MODELOS DE:  
 DOUBLE EFFET - 3 POSITIONS - RAPPEL RESSORT - A/B FERMEE - ORIFICES BSP - PREDISPOSITION POUR CENTRE A SUIVRE  
 DOUBLE ACTING TYPE - 3 POSITIONS - SPRING RETURN - A/B PORTS CLOSED - BSP THREADS - MACHINED FOR CARRY-OVER  
 DOBLE EFECTO - 3 POSICIONES - RETORNO POR MUELLE - A/B CERRADOS - ROSCAS BSP - PREPARADO PARA RETORNO A PRESION (CARRY-OVER)

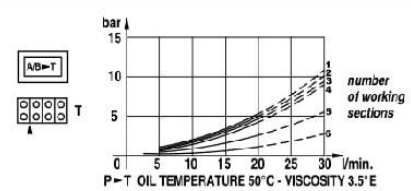
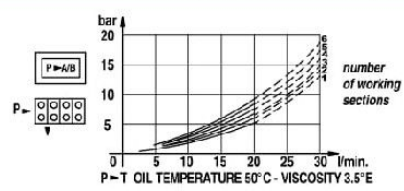
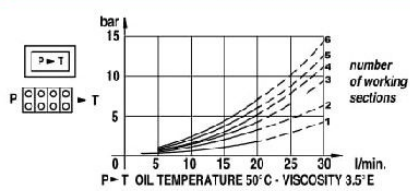

TIROIR SPOOL TYPE - CORREDERAS	
A	
B	
C	
D	
K	

POSITIONNEUR SPOOL CONTROL - POSICIONADOR	
1	
2	
3	
6	
7	
8	
16	

SUR DEMANDE ON REQUEST - BAJO PEDIDO	
MC	commande manuelle + teton manual operator with cam accionamiento manual con leva
MX	levier de sécurité safety lever palanca de seguridad
DO	came de commande cam operator control por levas
JS	double commande joystick joystick
MSW	microrupteur microswitch microinterruptor
CO	centre a suivre power beyond (carry over) retorno a presión (carry over)
CCP	centre fermé closed center plug centro cerrado

# BM35 da 1 a 6 leve

# BM35 from 1 to 6 levers

## Caratteristiche generali / Technical characteristics

	l/min GPM	
• Portata nominale / Nominal flow	25	6,6
• Portata limite / Max flow	35	9,2
	bar PSI	
• Pressione nominale / Nominal pressure	250	3600
• Pressione max sugli utilizzi / Max pressure on ports	320	4700
• Contropressione max allo scarico / Max pressure in tank-line	80	1100

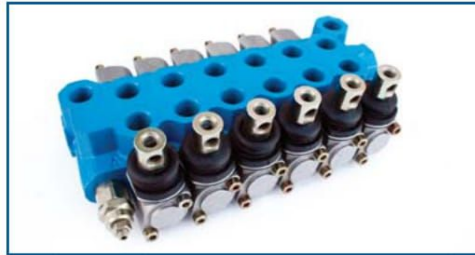

P-T - TEMPERATURA OLIO 50°C - VISCOSITÀ 3,5°E

P-A/B - TEMPERATURA OLIO 50°C - VISCOSITÀ 3,5°E

A/B-T - TEMPERATURA OLIO 50°C - VISCOSITÀ 3,5°E

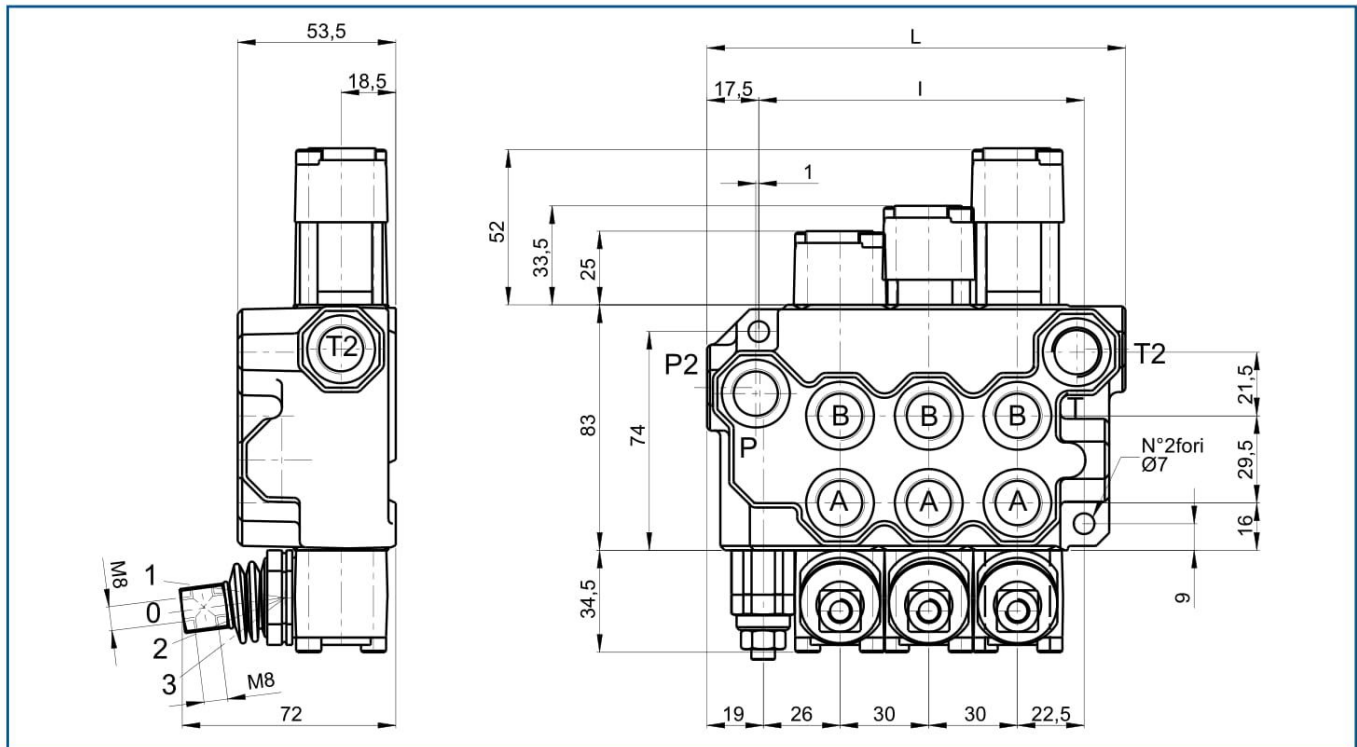
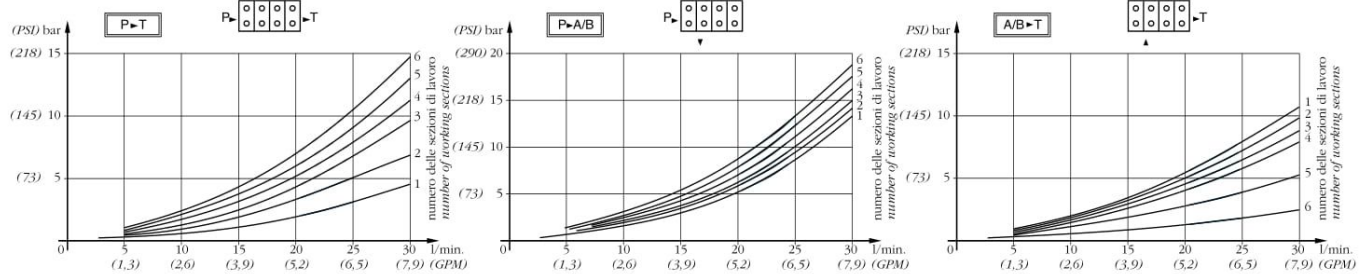

MOD	L	I	Kg
BM35/1	81,5	50	1,8
BM35/2	111,5	80	2,7
BM35/3	141,5	110	3,8
BM35/4	171,5	140	4,6
BM35/5	201,5	170	5,4
BM35/6	231,5	200	6,2

## FILETTATURA STANDARD - STANDARD THREADS

COD	A-B	P	T	P <sub>2</sub>	T <sub>2</sub>
G	3/8"	3/8"	3/8"	3/8"	3/8"
F	3/4" - 16	3/4" - 16	3/4" - 16	3/4" - 16	3/4" - 16

◀ Su richiesta filettature diverse  
Other threads available on request

